

Connecting the Terminal Block

Connect main supply (brown - Live, blue - Neutral) into terminal block making sure all connections are tight.

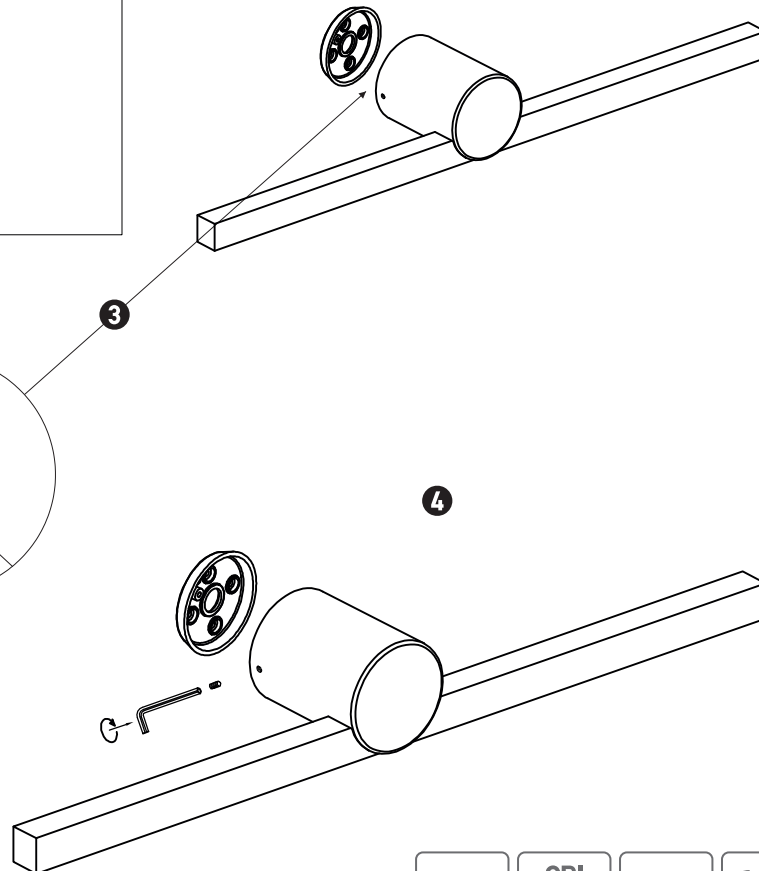
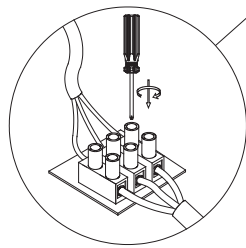
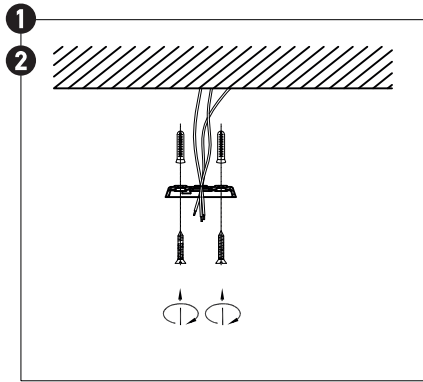

BATHROOM WALL LIGHT 22125

Please read instructions before commencing installation and retain for future reference.

SPECIFICATIONS

- **Material:** Aluminum + Acrylic
- **Lamp Type:** LED , 17W , 3000K , 2600Lm , CRI 81
- **Ingress Protection:** IP54. Protection against entry of solid objects greater than 12mm in diameter.

INSTALLATION INSTRUCTIONS

⚠ Electrical products can cause death, injury, or damage to property. Installation of this product must be carried out by a qualified electrician.

- Ensure main supply is switched off.
- Insert wall anchors into mounting surface (1).
- Fit mounting bracket onto mounting surface with self-tapping screws (2).
- Connect main supply wires to terminal block (3) making sure all connections are tight.
- Fit wall light onto mounting bracket with smallest screws (4).
- Reconnect power.

WARNING

- Make sure that the products is installed properly before connecting to electricity.
- Do not cover the fitting.
- Not for outdoor use or in wet conditions.

